

SE

H21 HULL/DECK

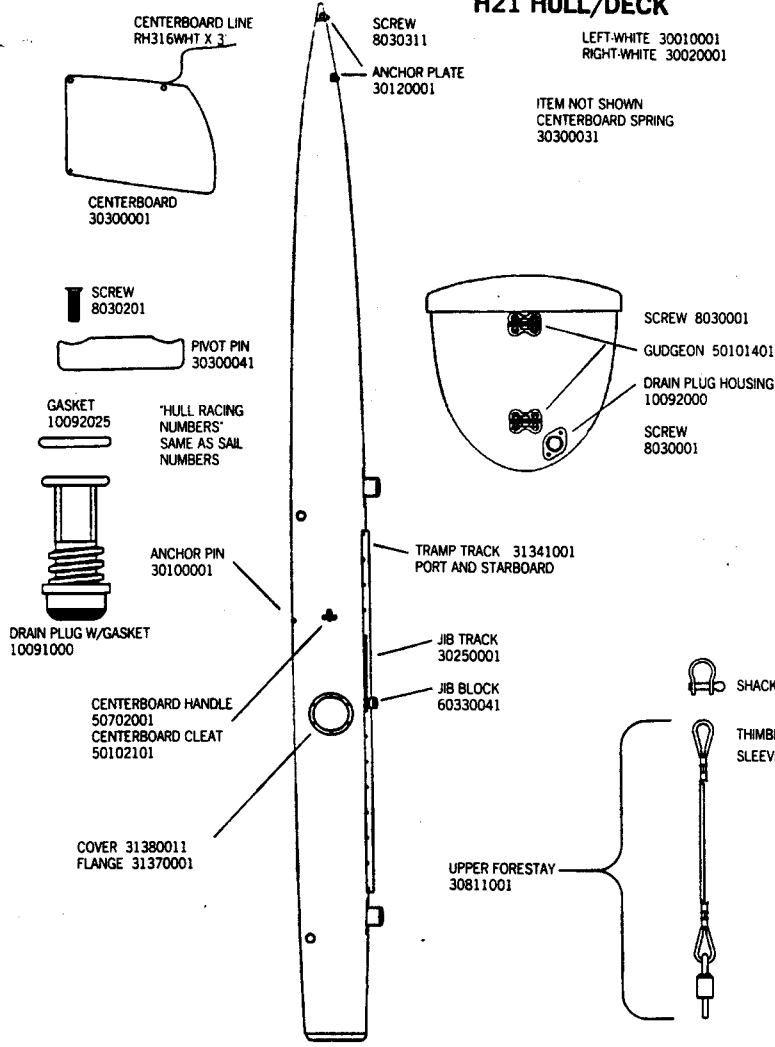

H21 MAST

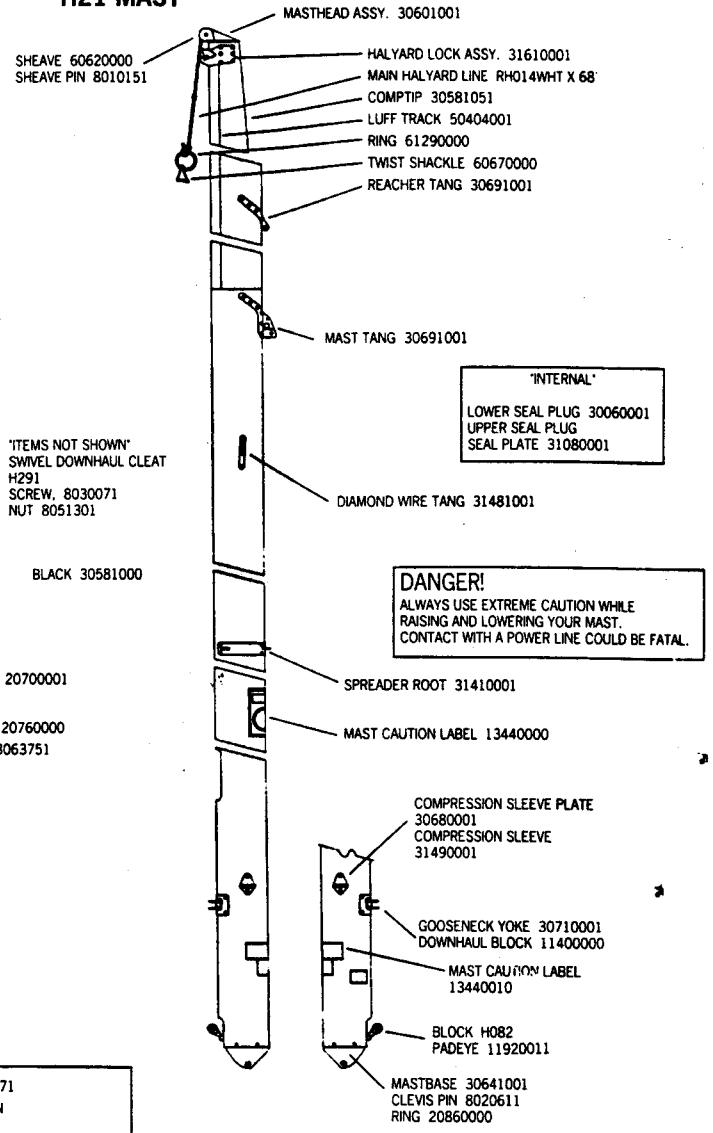

H21 FORESTAY AND JIB HALYARD

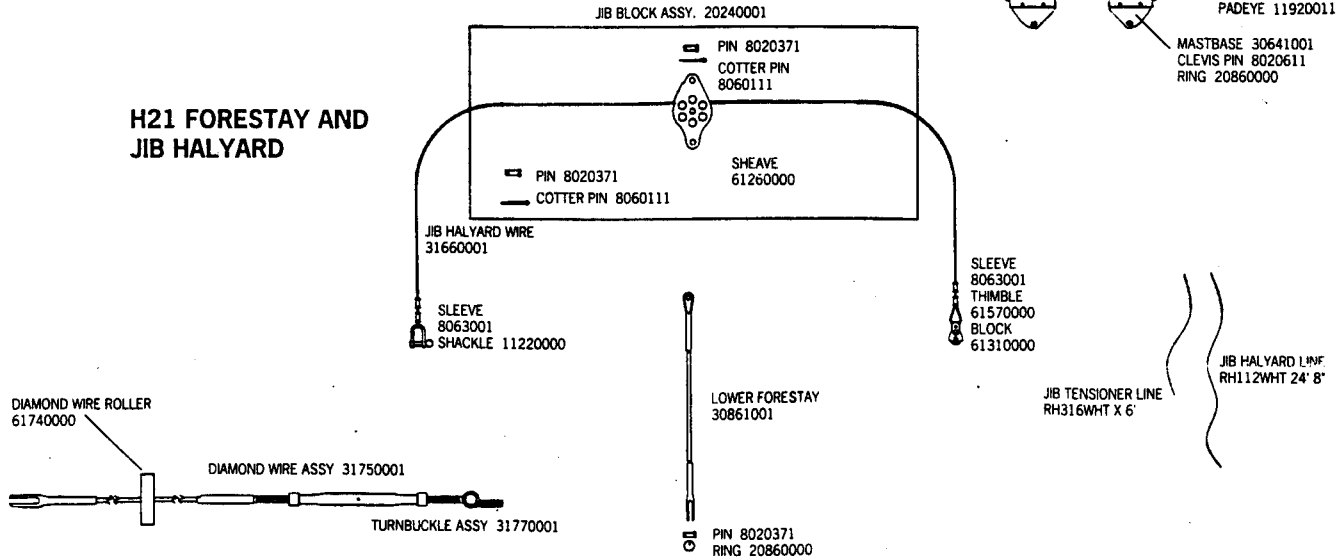

H21 DIAMONDS & ROTATER

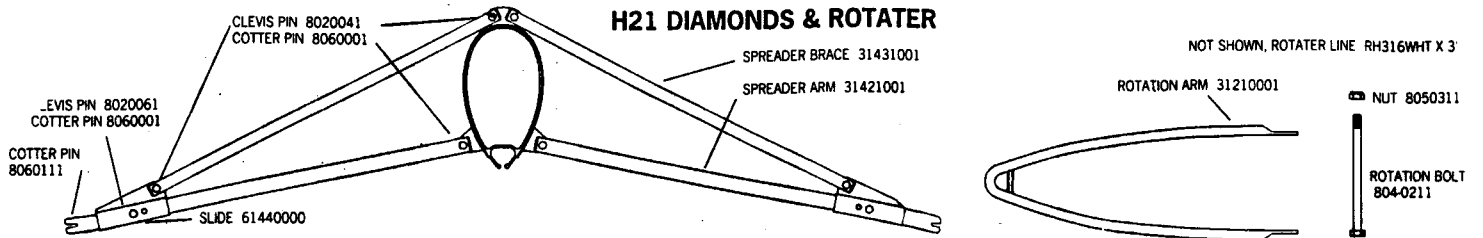

SE

H21 ROLLER FURLER AND BRIDLES

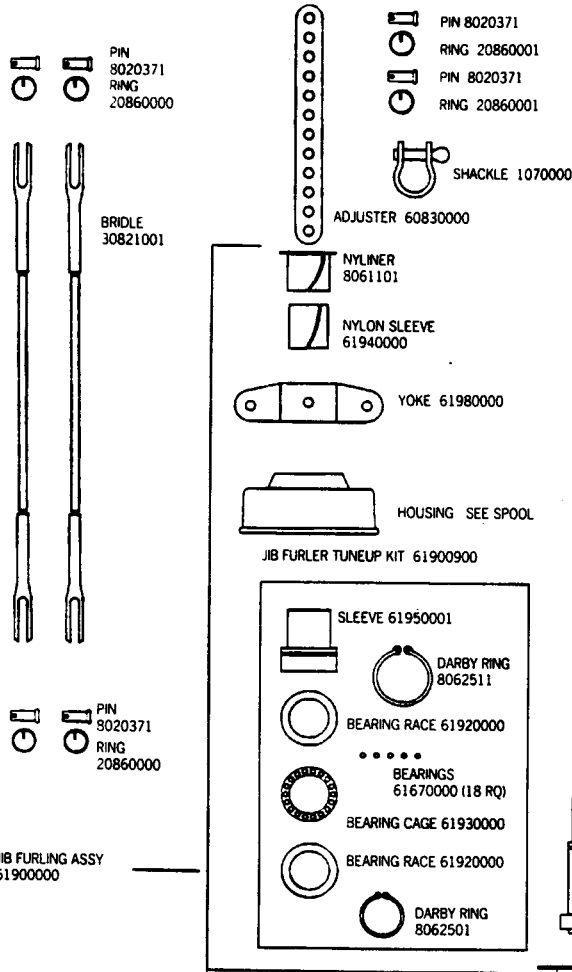

H21 REAR CROSSBAR

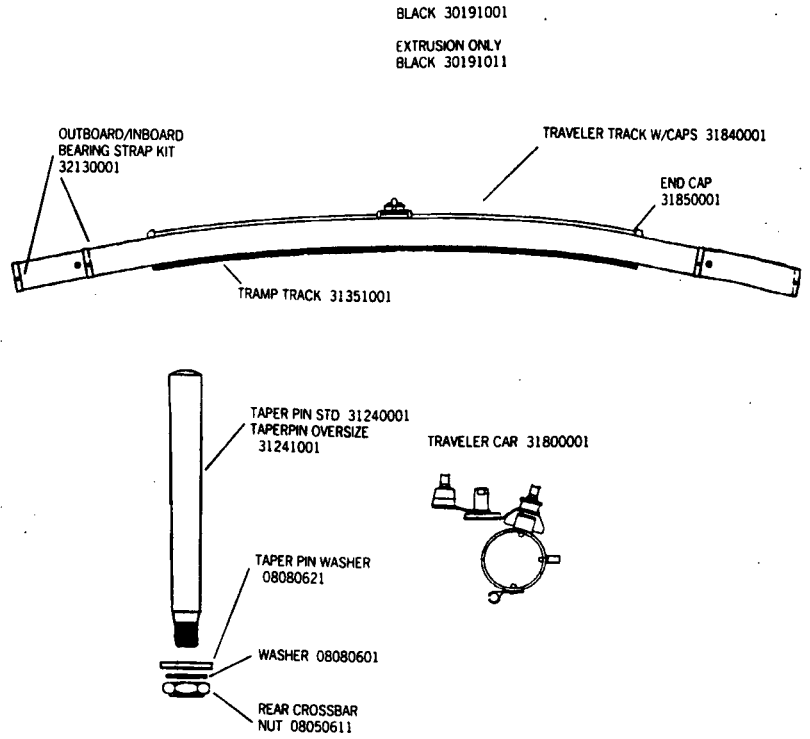

H21 SHROUDS & ADJUSTERS

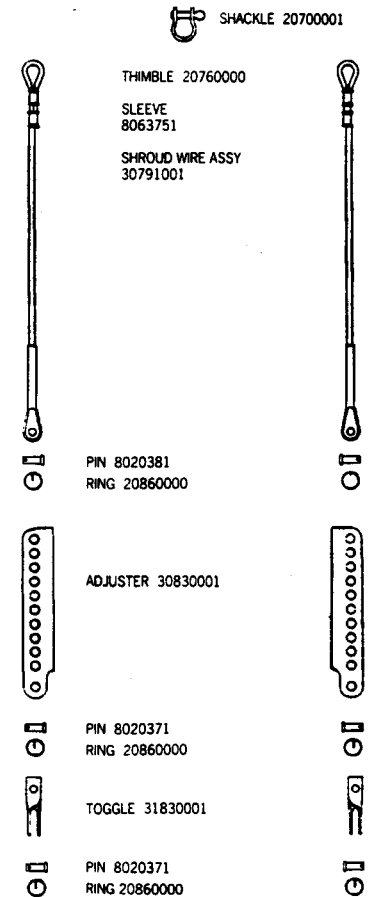

H21 TRAPEZE WIRES AND SEAT

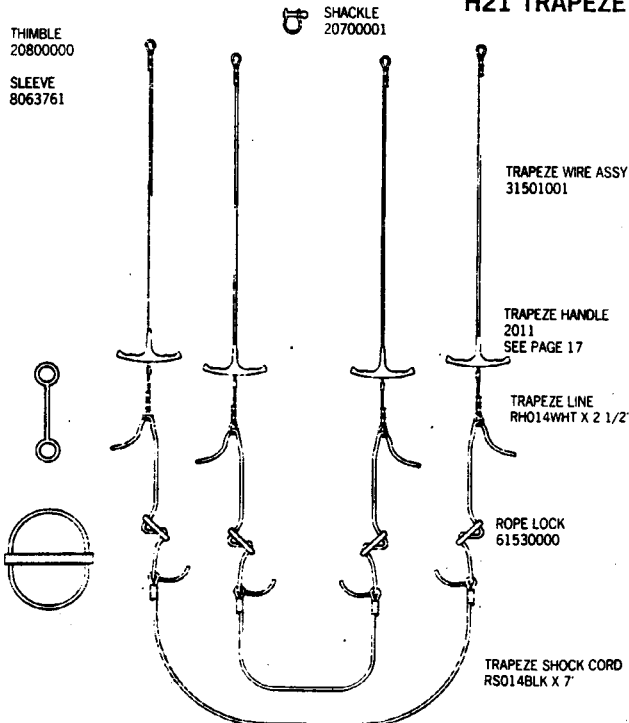

SE

H21 BOOM

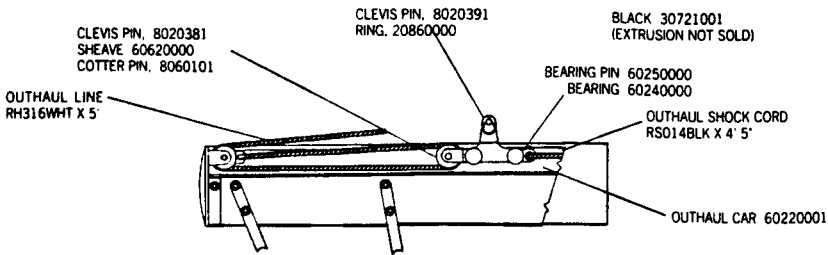

H21 TILLER CROSSBAR

BLACK 30520011

TILLER CONNECTOR KIT 11520005

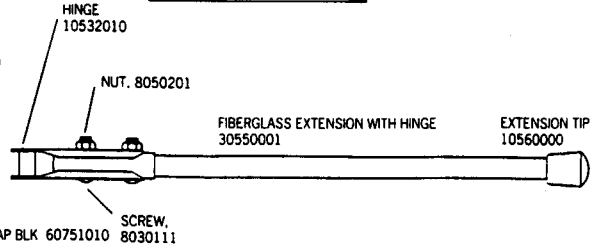
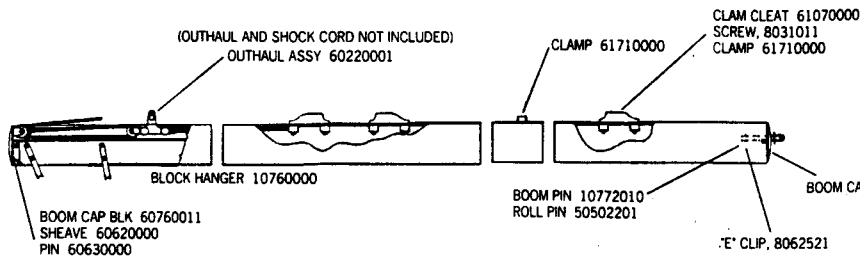
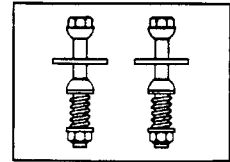

HINGE YOKE ASSY 3205
SEE PAGE 10

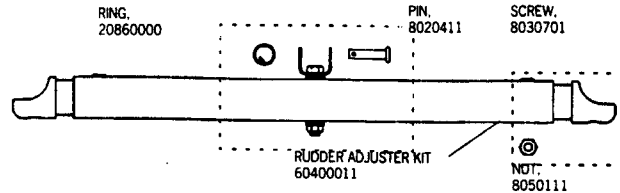

UPPER BLOCKS H003

MAINSHEET LINE RM716XXX X 68'

H21 BLOCK SET

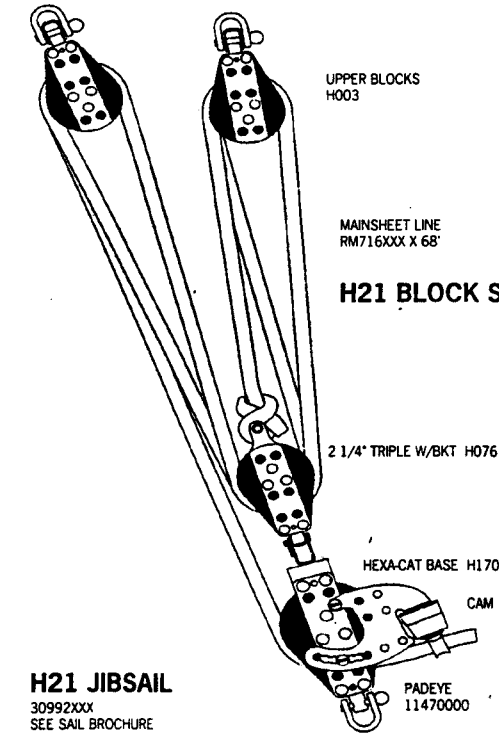

LEFT WING TRAMP
WHITE 68040141
BLUE 68040161
BLACK MESH 68040155

H21 WINGS

WING SET 35001001
DOES NOT INCLUDE TRAMPS
WING TRAMP SET
68040240 WHITE
68040210 BLUE
68040255 BLACK MESH

WING SUPPORT 35071001

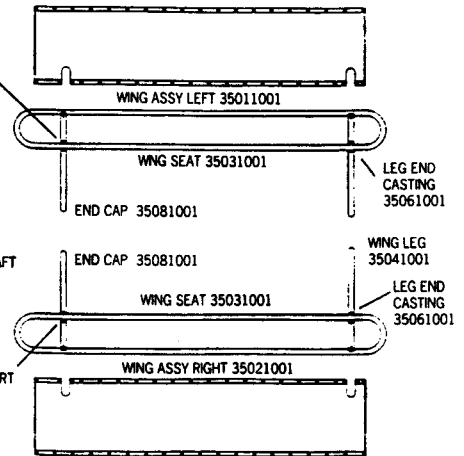

H21 MAIN SAIL

30991XXX
SEE SAIL BROCHURE

LOGO
BLACK 12430011
WHITE 12430001

HEADBOARD 32331001



BATTEN POCKET PROTECTOR KIT 80550005

WIND INDICATOR 335
SEE PAGE 8

BATTEN TIP 11323000
SEE PAGE 38

LUFF TIP 11322011
SEE PAGE 38

CLASS INSIGNIA 32330001

WING LEG AFT 35051001

WING SUPPORT 35071001

TWIST SHACKLE 60670000

DOUBLE BLOCK 5.1
DOWNHAUL
SEE PAGES 22

CLEW PLATE 62270000

SAIL BAG 21310000

BATTEN SET 32000001

FOR INDIVIDUAL BATTENS SEE PAGE 38,
UNIVERSAL BATTENS.

H21 JIBSAIL

30992XXX
SEE SAIL BROCHURE

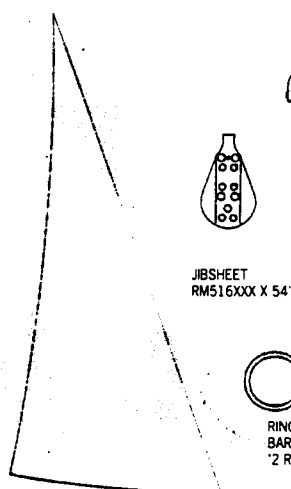

H21 FRONT CROSSBAR

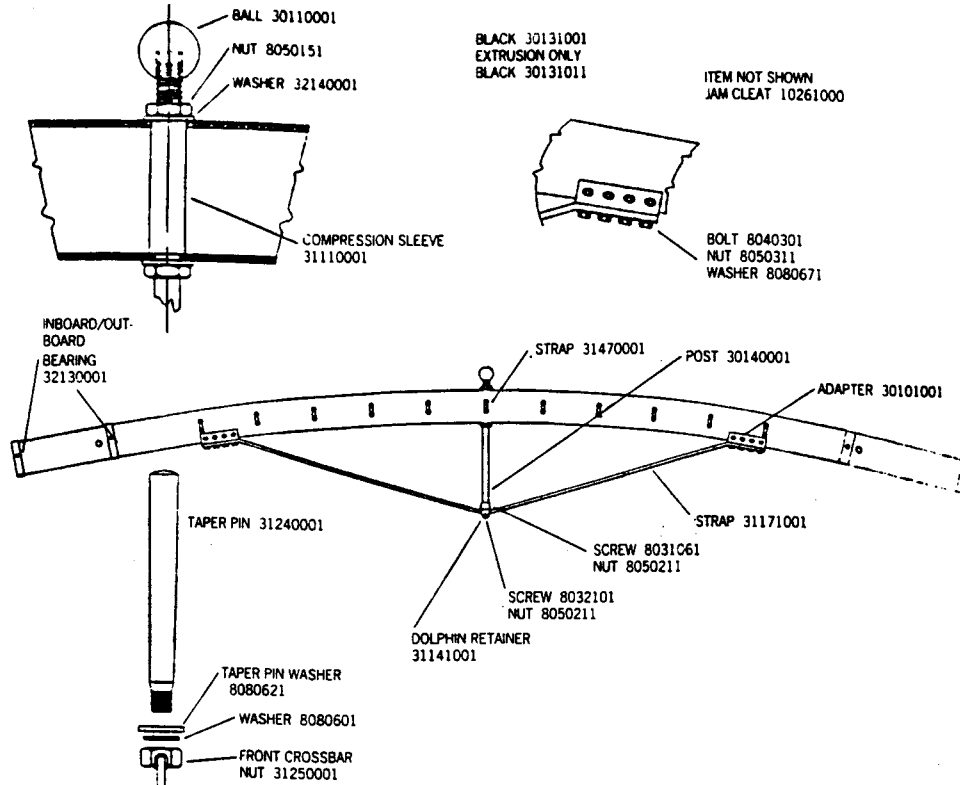

H21 TRAMPOLINE

WHITE 30970000
BLUE 30970010

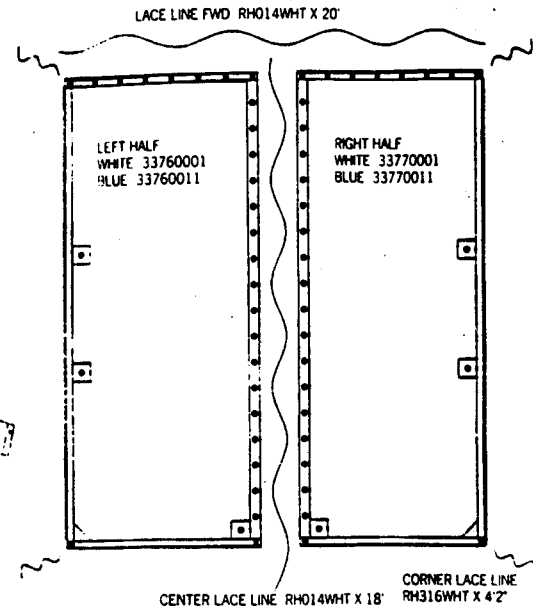

H21 RUDDER ASSEMBLY

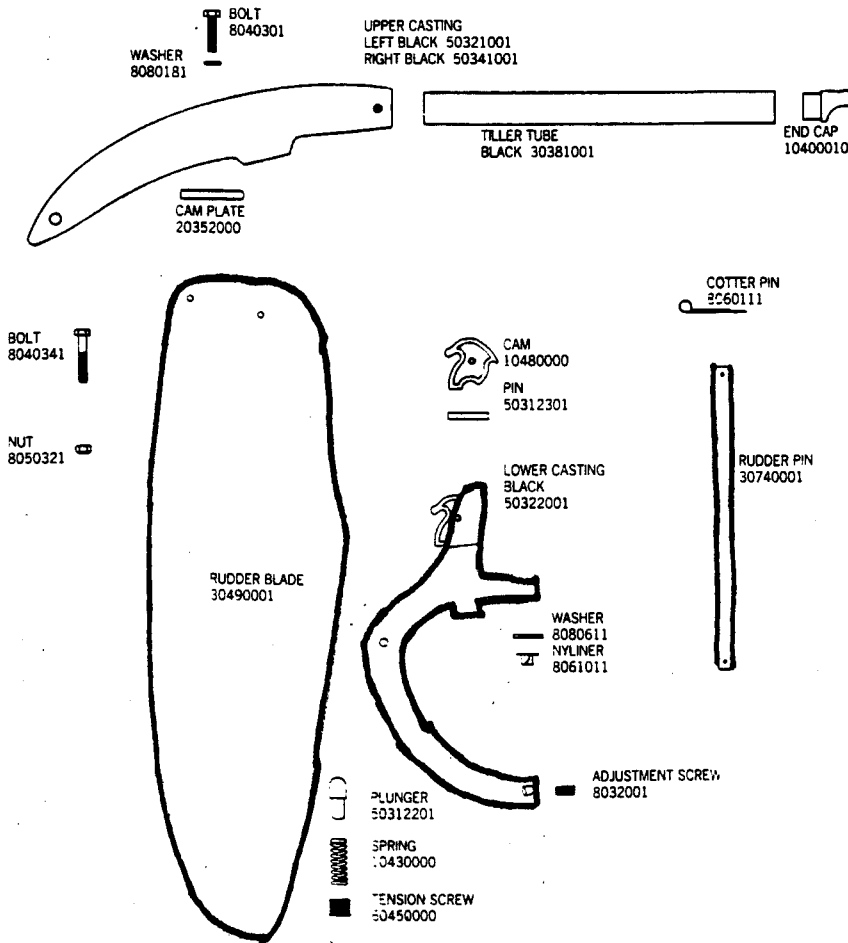

HOBIE 21 CLEVIS PIN GUIDE

	Length & Dia.	Usage
8020041	3/16" X 5/8"	Spreader Brace
8020061	3/16" X 13/16"	Spreader Arm
8020371	1/4" X 1/2"	Wires
8020381	1/4" X 5/8"	Gooseneck Vertex, Outhaul Car Sheeve
8020611	5/16" X 2 1/8"	Mastbase Step Pin

Length = Underside of head to centerline of hole

RIVET USAGES

	RIVET USAGES	HULL/DECK	
MAST		Tramp Track	8010121 (13)
Halyard Lock Assy	8010131 (6)	Job Track	8010201 (10)
Reacher Tang	8010131 (6)	RUDDER	
Mast Tang	8010121 (10)	Tiller Arm	8010131 (5)
Diamond Wire Tang	8010131 (4)		
Spreader Root	8010131 (8)		
Compression Sleeve Plate	8010131 (4)		
Gooseneck Yoke	8010131 (4)		
Mast Eyestraps	8010131 (2)		
Mast Base	8010131 (5)		
Mast Head	8010131 (6)		
BOOM			
End Cap	8010131 (2)		
Block Hanger	8010181 (4)		
Eyestraps	8010231 (2)		
REAR CROSSBAR			
Outboard Bearing	8010051 (8)		
Inboard Bearing	8010051 (8)		
Eyestraps	8010131 (2)		
Tramp Track	8010131 (16)		
Traveler Track	8010171 (17)		
FWD CROSSBAR			
Outboard Bearing	8010051 (8)		
Inboard Bearing	8010051 (8)		
Jam Cleat	8010231 (2)		
Adapter Casting	8010231 (8)		
Eyestraps	8010231 (2)		

RIVET SPECIFICATIONS

8010051	4-8 Csk. Aluminum
8010121	3/16" x 5/8" Pan Head
8010131	3/16" x 3/8" Pan Head
8010151	3/16" Tubular St. St.
8010171	3/16" x 3/4" - 1" Grip Range
	Csk.
8010231	3/16" x 1/2" Pan Head
8011291	Rivet Cap
	All 8010131 Rivet require 8011291 Rivet Caps